

# INDEPENDENT DEALER THURSDAY POOLS

Your weekend starts early with us...®



## Fiberglass Pool Designs

### GOLIATH\*

12' x 25' 5.4" 14' x 29' 5.8" 14' x 33' 6"  
16' x 33' 6" 16' x 37' 6.4" 16' x 41' 6.8"

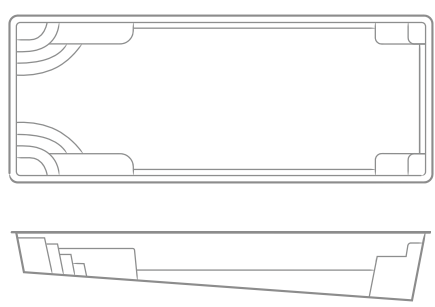

### GRACE BEACH ENTRY\*

14' x 36' 5.6" 16' x 36' 5.6"  
16' x 40' 5.10"

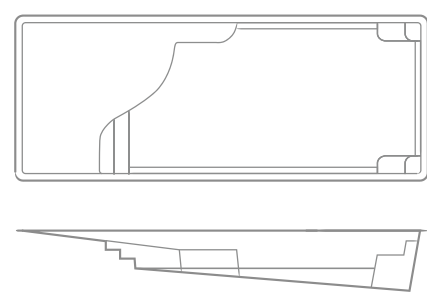

### MONOLITH\*\*

16' x 40' 8.6"

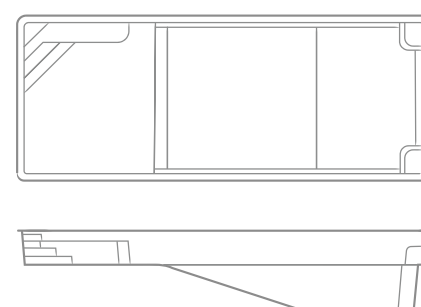

### LIL BOB LX\*

13.5' x 35.5' 4.6"

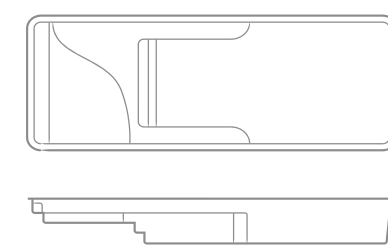

### LIL BOB\*

13.5' x 27.5' 4.6"

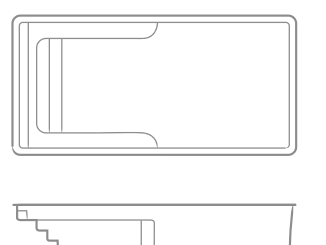

### SPIRIT\*

13.5' x 40' 4.6"

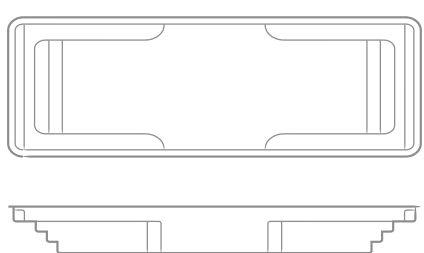

### CATHEDRAL LX\*

16' x 36' 5.8" 16' x 40' 6"

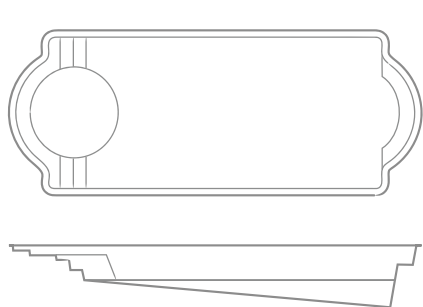

### CATHEDRAL\*

14' x 33' 5"

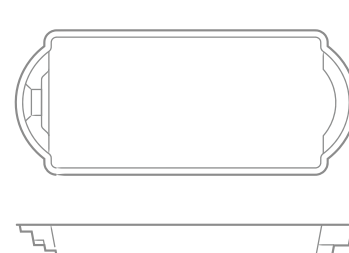

### TITUS\*

12' x 26' 5.5" 14' x 33' 5.10"

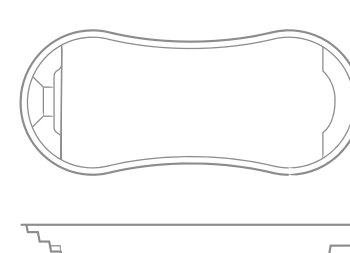

### SEA TURTLE\*

9.5' x 19.5' 4.6"

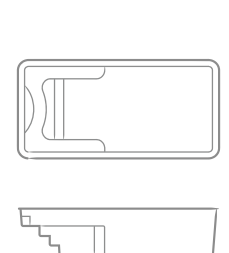

### ASPEN\*

12' x 25' 5.1" 14' x 30' 5.6" 14' x 35' 5.6"  
16' x 35' 5.6" 16' x 40' 5.10"

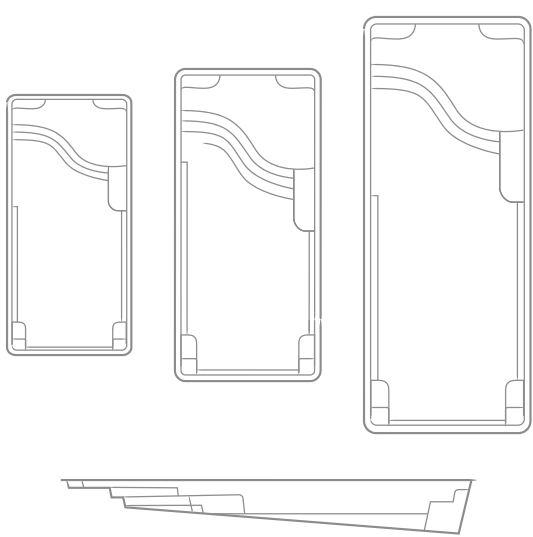

### WELLSPRING\*

16' x 36' 5.10" 16' x 40' 5.10"

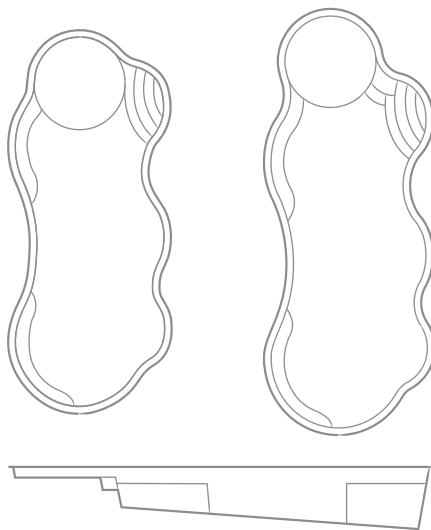

### SANDAL BEACH ENTRY\*

16' x 34.5' 5.8" 16' x 39' 6"

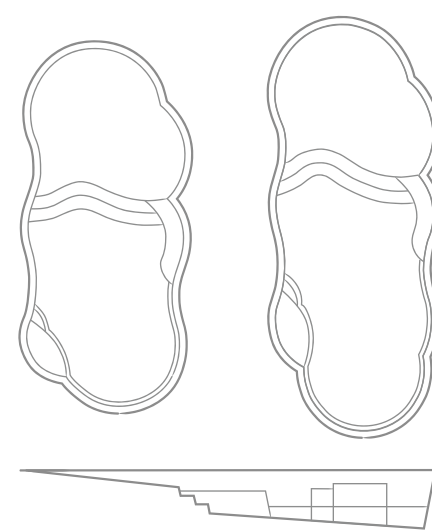

### SUN DAY\*

15' x 30' 5.3" 16' x 34.5' 5.8"  
16' x 39' 6"

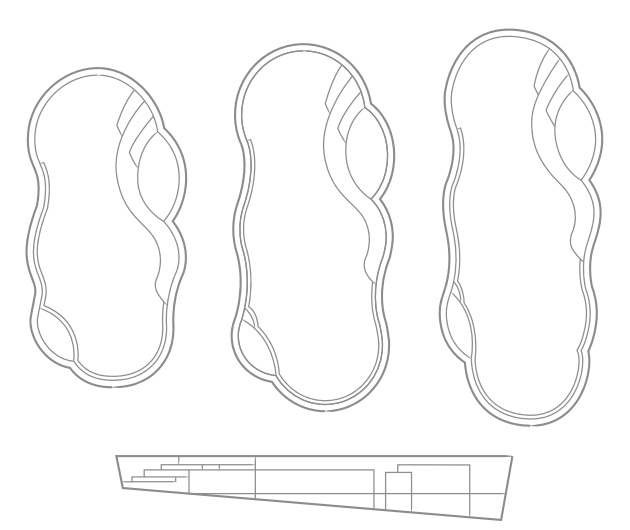

### PEARL\*

15' x 25' 3.9"

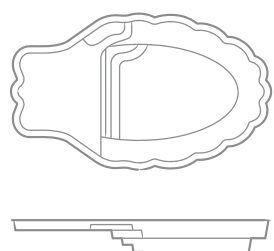

### SPA\*

9' x 9' 3.2" 9' x 9' 3"  
8'6" x 8'6" 3"

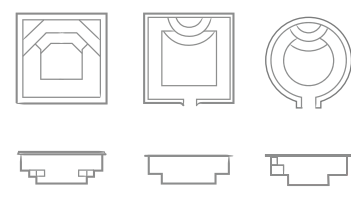

### GRAND SPA\*

11'6" x 11'10" 3"

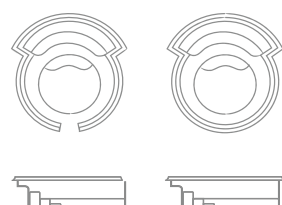

### WET DECK\*

14' x 8' 1"

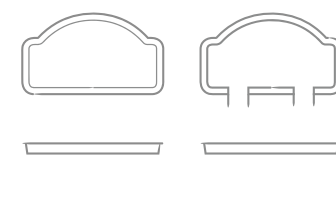

### WADING POOL\*

9' x 9' 1.6" 13'9" x 11'9" 1.6"

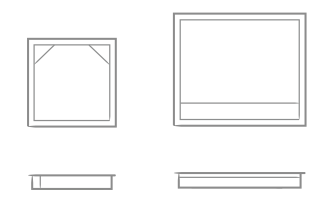

\*Non-Diving Pool

\*\*Type 1 Diving Pool

## Disclaimers

1. All depths reflect the depth of the pool structure. Water depths vary depending on the amount of water in the pool.
2. All measurements given reflect the dimensions of the pool to the exterior of the pool structure, and not the dimensions of the pool interior.
3. Additional specifications are available at [thursdaypools.com](http://thursdaypools.com).

Thursday Pools strongly recommends that diving boards and slides not be installed or used with its pools, given the inherent dangers associated with diving boards and slides in residential pools. These dangers include brain, spinal cord and other severe permanent injuries, and death. For that reason, Thursday Pools does not manufacture or sell diving boards or slides. If, despite this warning and recommendation, the owner decides to install or use a diving board or slide, the owner assumes all risks inherent with a diving board or slide, and Thursday Pools further warns that diving boards and slides require minimum depths and distances and must be installed and used in strict compliance with the equipment manufacturer's specifications and ANSI/NSPI, ANSI/APSP, and ANSI/APSP/ICC standards, as well as in compliance with all applicable laws, rules and regulations. The owner is responsible for making sure the pool is appropriate for diving boards and slides and otherwise meets all standards and laws for diving pools, and the owner must consult the diving board or slide manufacturer and/or installer as to the appropriateness of the pool for the diving board or slide and that its installation, location and use meet all standards and laws for diving and slide pools.

840 Commerce Parkway, Fortville, Indiana 46040

Tel: 877-929-POOL (7665)

Monday-Friday: 8:00 AM-5:00 PM EST

Visit us at [Thursdaypools.com](http://Thursdaypools.com)

